

Chain Link Heavy Duty Surface Mounting Post

2" [1 7/8" Outside Dimension] Round x 48" High Support Post
 Welded To Steel 4" x 4" (1/4" Thick) Steel Plate for Fencing (SS40 Pipe)

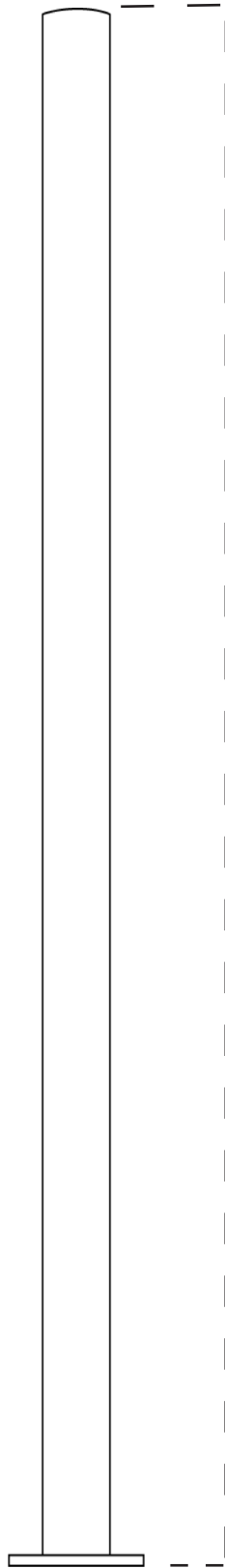

**SS40
 Commercial
 Grade**

Overhead View

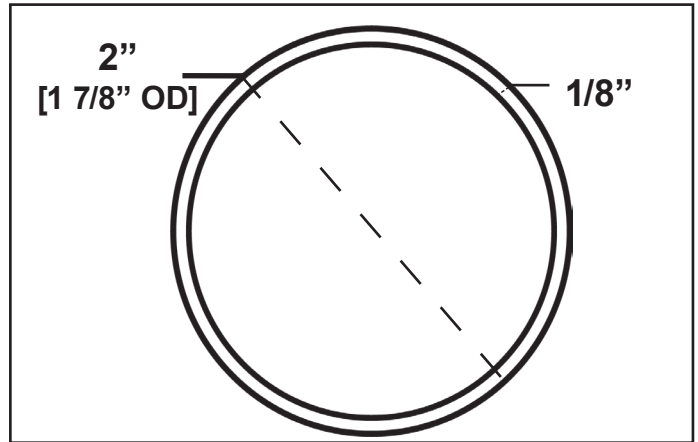

Welded On Plate - Bottom View

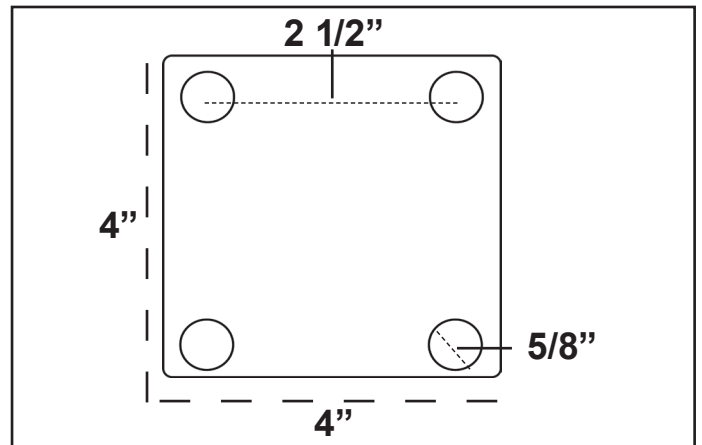

Welded On Plate - Side View

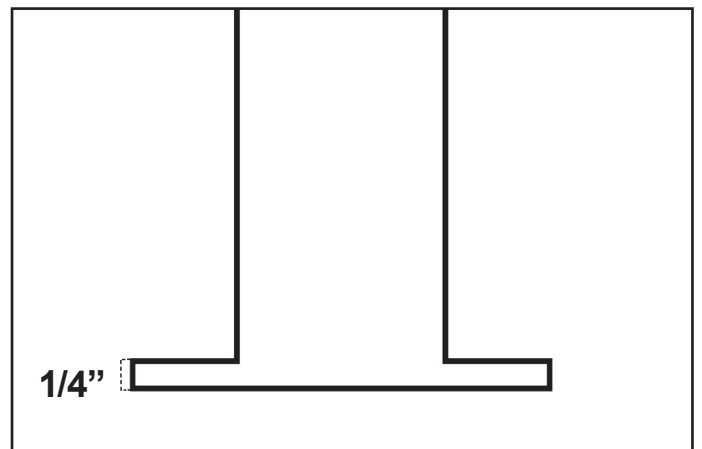

Part Number: HDCSP48		Contact Information:	Manufacturer:	Made in America Meets the Buy American Act
Height: 48"	Gauge: SS40	Website: www.ChainLinkFittings.com	DF Supply, Inc. 8500 Hadden Road Twinsburg, Ohio 44087	
Diameter: 2" [1 7/8" OD]	Wall Thickness: 0.120"	Phone: (800) 878-7829		
Material: Galvanized Steel	Base Plate Size: 4" x 4" Sq.	Email: Sales@ChainLinkFittings.com		